

INSTALLATION, COMMISSIONING AND OPERATION MANUAL

Edge Communication Hub

EE-502-0003

DOCUMENT INFORMATION

Document ID	E-IM-EE-502-0003	Version	A1
Prepared by	E.K. Palmes / J. Mozo	Date of Issue	1/28/2026

APPROVED BY

Engineering Manager	Jian Carlo Zapata	Date:
---------------------	-------------------	-------

REVISION HISTORY

Revision no.	Date of Revision	Revision no.	Date of Revision
A1	1/28/2026		

CHANGE RECORD

Revision no.	Prepared by	Description on Changes
A1	E.K. Palmes / J. Mozo	Initial Release

INSTALLATION, COMMISSIONING AND OPERATION MANUAL

Edge Communication Hub

EE-502-0003

TABLE OF CONTENTS

TABLE OF CONTENTS	2
I. PRODUCT DATASHEET.....	3
1. Features.....	3
2. Description	3
II. BOX CONTENTS	6
1. EE-502-0003 Edge Communication Hub Indoor Unit.....	6
2. EE-702-0001 Communication Hub Outdoor Enclosure with PSU and Mounting Accessories.	6
III. INDOOR INSTALLATION PROCEDURE	7
1. Indoor installation Assembly	7
IV. OUTDOOR INSTALLATION PROCEDURE	8
1. Outdoor Accessories Assembly	8
2. Powering the Edge Communication Hub Outdoor Unit.....	9
3. Circular Mount Accessory Installation.....	12
4. Stobie Mount Accessory Installation.....	13
5. Pad Mount Accessory Installation	14
V. DEVICE USAGE.....	15
1. Accessing Edge Communication Hub UI.....	15
2. LEDs and Buttons.....	21
3. Diagnostic Tool for Edge Devices	22

I. PRODUCT DATASHEET

1. Features

Edge Communication Hub

- Connects to the Edge devices through LoRa and Wi-Fi
- Pairs with smartphones, tablets, and laptops via Wi-Fi for commissioning and diagnostics of Edge devices
- Simple web-based User Interface to display diagnostic and real-time power quality data, and to issue commands to Edge devices wirelessly
- Functions as a gateway to the Edge Cloud using Ethernet, Wi-Fi, 4G or LoRa
- Powered by an external 5V 2A supply through a standard USB Type A connection
- PoE Powered Device. 802.3af, Type 1 – Class 3



2. Description

The Edge Communication Hub functions as a gateway that relays real-time power quality and energy data of Edge devices to the Edge central cloud server. It is also used to diagnose and monitor the performance of Edge devices in the field. This device offers multiple connectivity options including LoRa, Wi-Fi, Ethernet, and 4G Cellular for seamless integration with Edge Products and aligns with the roadmap.

Powered by an external 5V supply via a standard USB connection, the device ensures mobility and ease of use. It is also a PoE Powered Device (802.3af compliant) for streamlined wired power and connectivity. It can be paired with smartphones, tablets, and laptops via Wi-Fi. The device serves a web-based user interface via Wi-Fi to the paired device that can display diagnostic data, real-time power quality data, and can also issue commands to Edge devices directly without connecting to the Edge central Cloud Server.

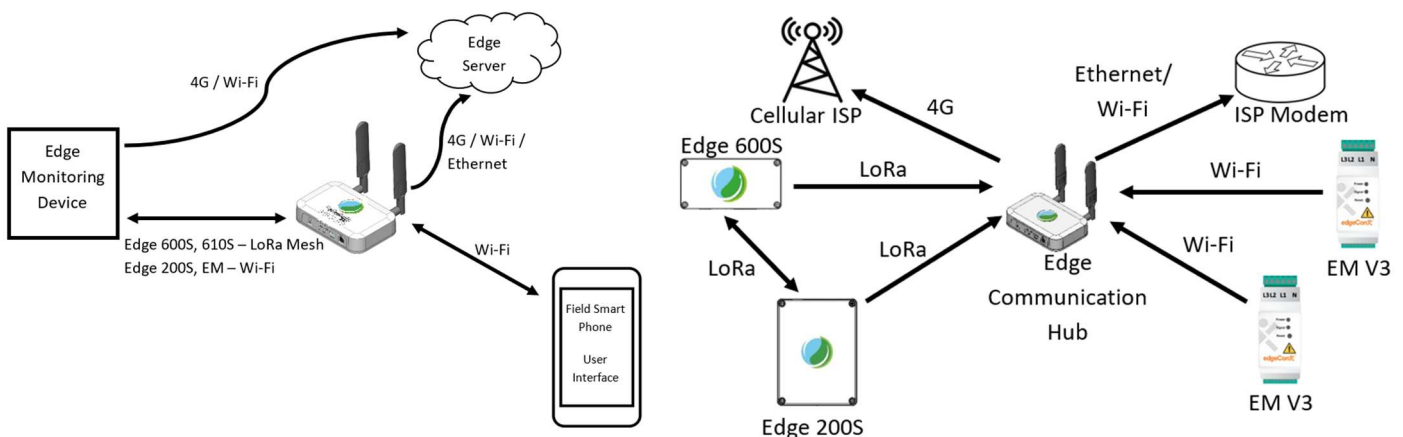

Electrical Specifications

Rated Input	5V / 2A, USB Type A; PoE Class 1, Type 3, 15.4W
-------------	---

Connectivity

Communications	Wi-Fi, Cellular (4G CAT-1), Ethernet, Edge LoRa Mesh
----------------	--

Communications Architecture	<p>Gateway connection to Edge central IoT Cloud server</p> <p>Wi-Fi serves as Device commissioning and gives access to user interface</p> <p>Edge LoRa Mesh allows connection to Edge Devices LoRa Network</p>
-----------------------------	--

Compatible Hardware	<p>EdgeSensor 200 Series, 600 Series and 610 Series, – LoRa Mesh</p> <p>EdgeSensor 200 Series, Energy Monitor v3 – Wi-Fi</p>
---------------------	--

Mechanical and Environmental Specifications for Indoor Base Unit

Dimensions	L 100 x W 150 x H 30mm
Weight	270g
IP Rating	IP2X
Operating Temperature and Humidity	-10°C to 60°C, 0-95% RH non-condensing
Storage Temperature	-30°C to 80°C
Operating Altitude	1000m

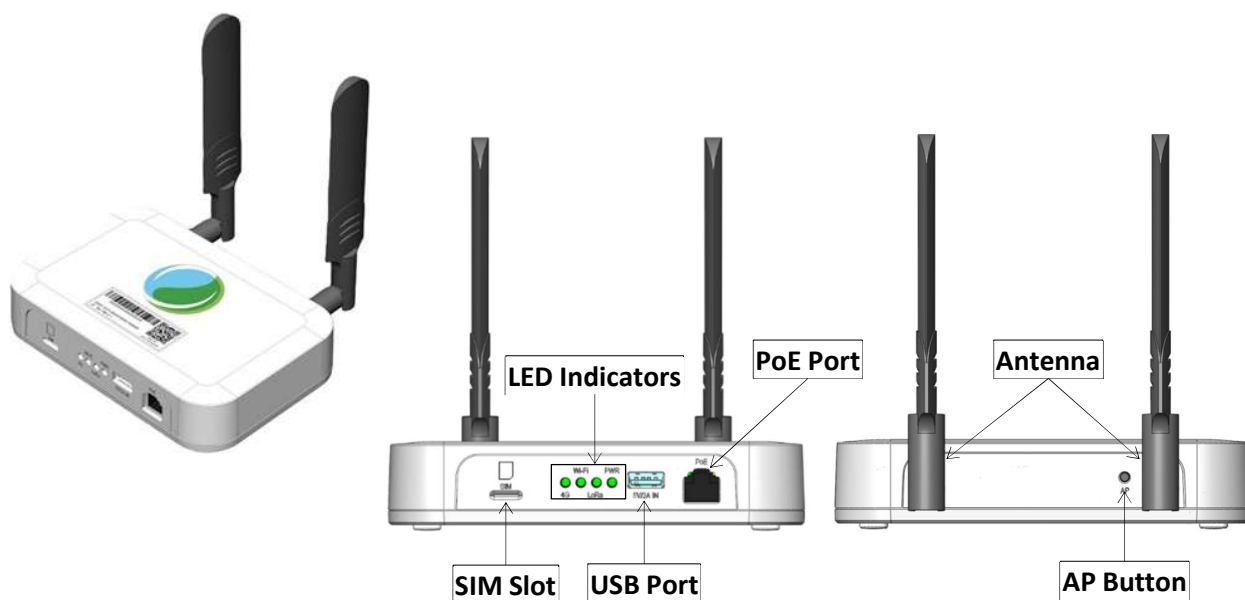
Indoor Base Unit



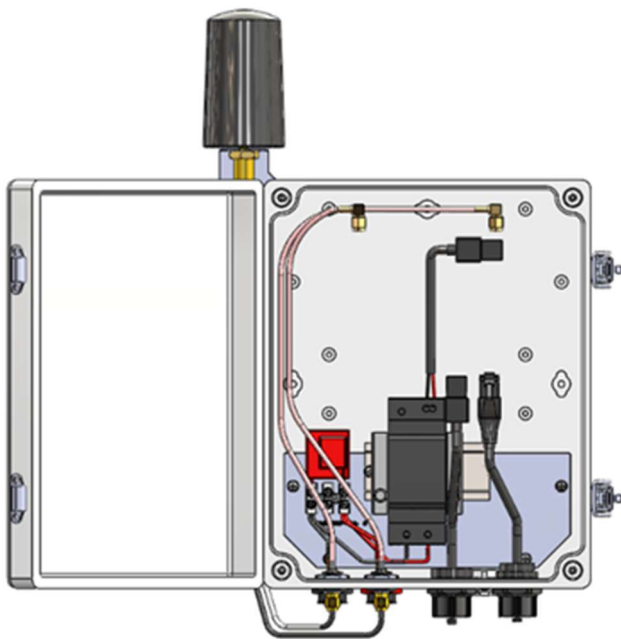
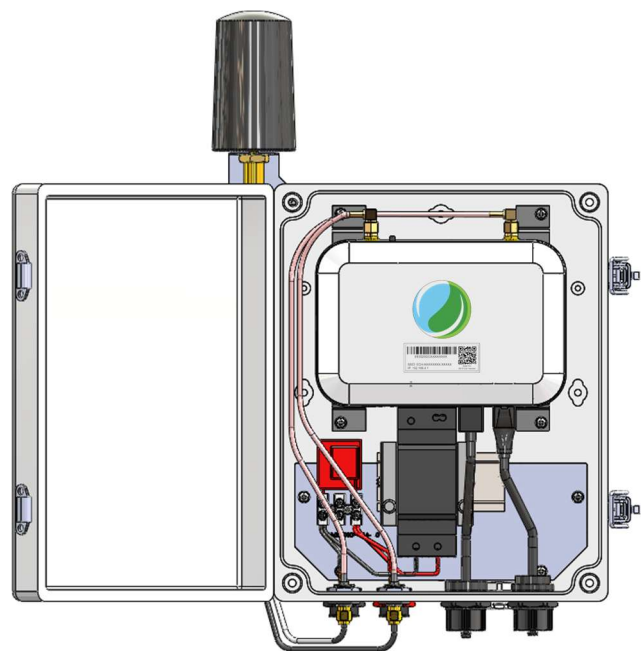
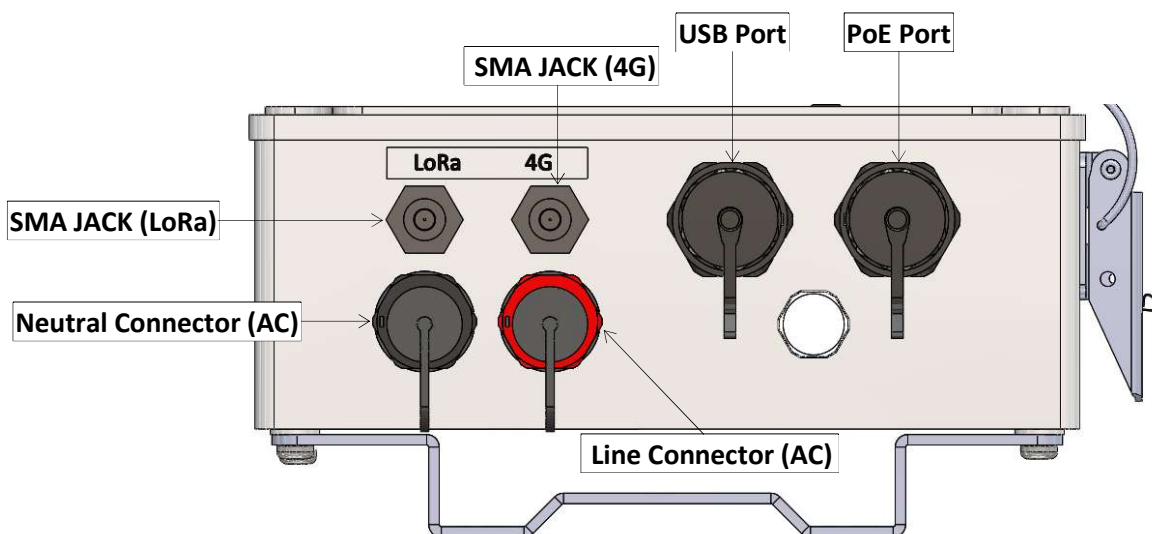

Specifications for Outdoor Accessories Bundle

Dimensions	L 250 x W 200 x H 100mm
Weight	3kg
IP Rating	IP66
Rated Input	100-250Vac; 5V / 2A, USB Type A; PoE Class 1, Type 3, 15.4W
Frequency for AC Input	50/60 Hz
Max Rated Power	10W Max.
Overvoltage Category	Cat. III
Operating Temperature and Humidity	-10°C to 50°C, 0-95% RH non-condensing





Outdoor Accessories Bundle

**Outdoor Accessories Bundle
with Base Unit Installed**

II. BOX CONTENTS

1. EE-502-0003 Edge Communication Hub Indoor Unit

<p>Base Unit</p> 	<p>Manual</p> 
<p>4G Antenna & LoRa Antenna</p> 	<p>Extension cable-USB 2.0 (L = 0.9m)</p> 

2. EE-702-0001 Communication Hub Outdoor Enclosure with PSU and Mounting Accessories.

<p>Pre-assembled Outdoor accessories</p> 	<p>Base Unit mounting</p> <p>M2.6 Screw</p> <p>M4 Screw</p> 	<p>2in1 4G and LoRa Antenna (L = 2.5m) and bracket</p> 
<p>External Ethernet cable (L = 3m) and external USB cable (L = 0.9m)</p> 	<p>Line and Neutral Wire assembly (L = 3m)</p> 	<p>Universal Mounting</p> 

III. INDOOR INSTALLATION PROCEDURE

1. Indoor installation Assembly

① Install the two antennas: connect the LoRa antenna to the LoRa port, and the 4G antenna to the 4G port.

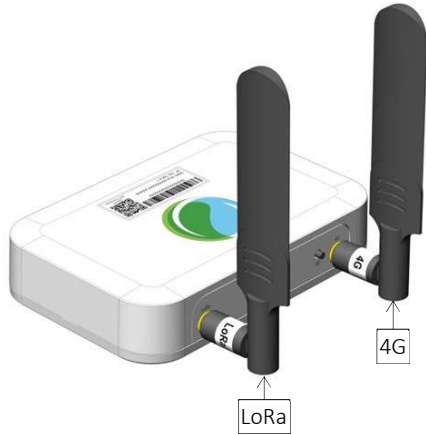

② These two ports—PoE and USB—are available options for powering the device.

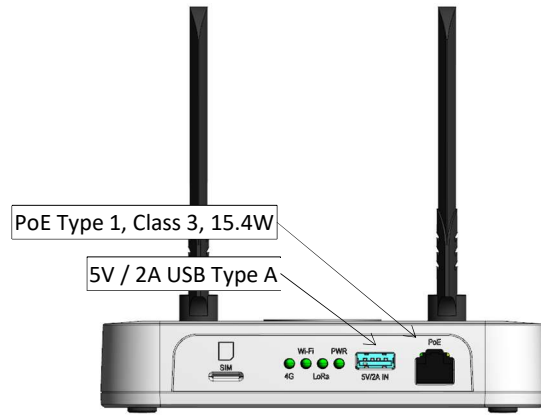

③ **Option 1:** USB power (5V/2A) using an external adaptor.



④ **Option 2:** Power over Ethernet (PoE) connection.



⑤ **Option 3:** Combined USB and PoE for power redundancy.



⑥ **Option 4:** Ethernet for data only, with USB used for power.



IV. OUTDOOR INSTALLATION PROCEDURE

1. Outdoor Accessories Assembly

① Remove all the rubber foot from Com Hub Unit, then screw it onto bracket using M2.6 screws, applying a torque of 0.10-0.15 N-m.

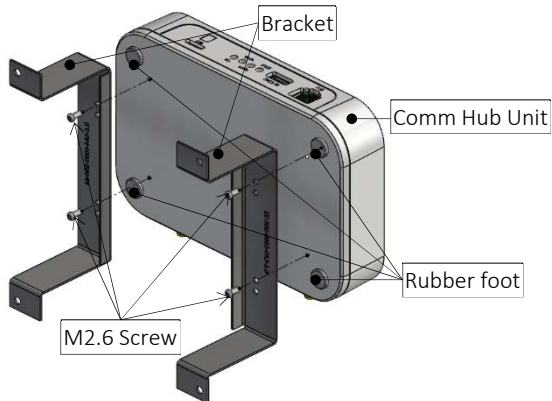

② Screw the brackets to the enclosure Using M4 screws with a torque of 1.50-1.75 N-m



③ Secure the connection between SMA Jack Male and Female: connect LoRa to LoRa and 4G to 4G.

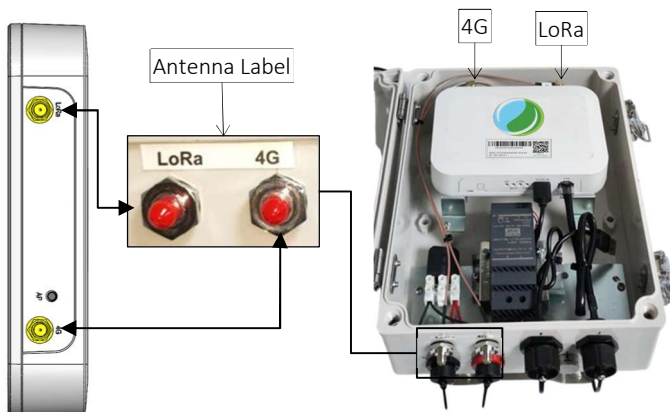

④ Install the Antenna Bracket Using M5 Screw with a torque of 1.5-1.6N-m.

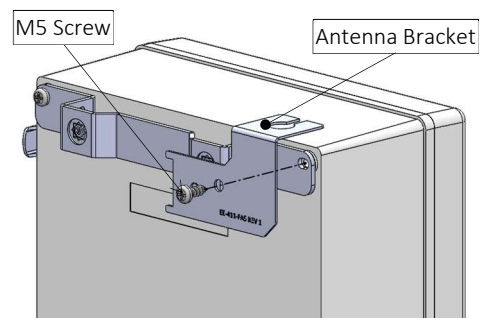

⑤ Mount the Antenna-to-Antenna Bracket.

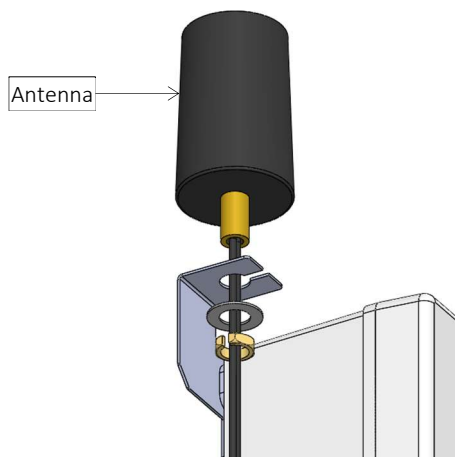

⑥ Connect the white-sleeved wire to the LoRa port, and the non-sleeved wire to the 4G port.

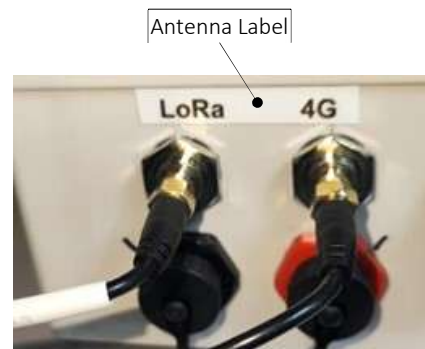

2. Powering the Edge Communication Hub Outdoor Unit

2.1 AC INPUT

STEP 1:

Take off the cap cover by twisting it counterclockwise.

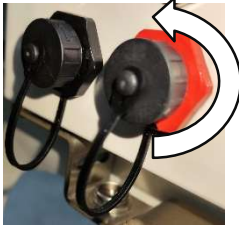

STEP 2:

Insert the male connector into the matching color-coded female connector. Ensuring it is securely mated with an audible click to confirm proper engagement.

STEP 3:

Final assembly of the Voltage Line accessory.

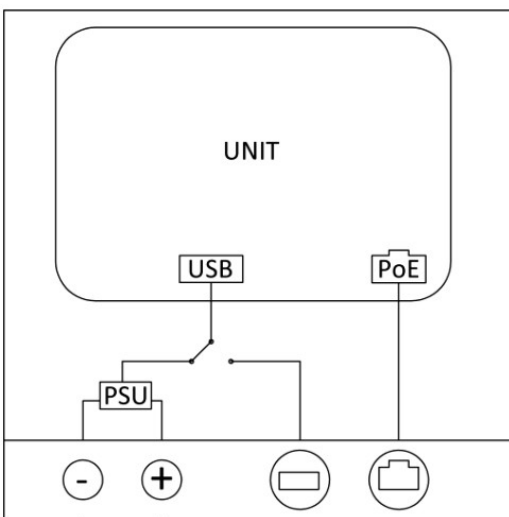



UNIT

USB PoE

PSU

- + [] []

AC INPUT

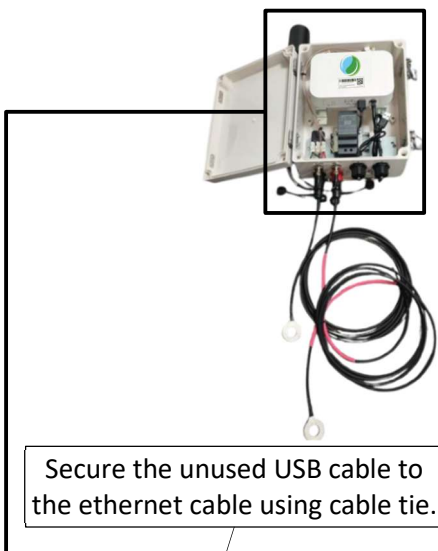

Maintain this connection

Secure the unused USB cable to the ethernet cable using cable tie.

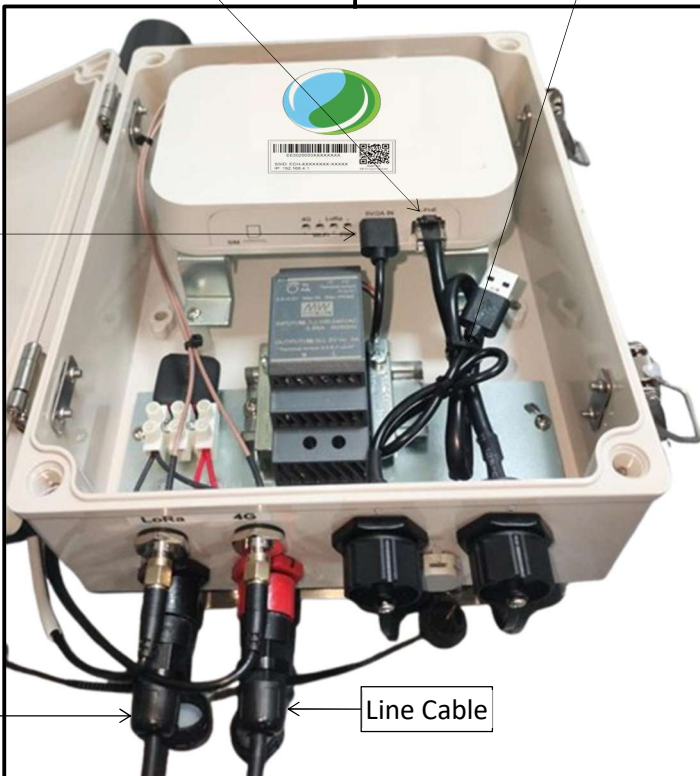

USB from PSU

Neutral cable Line Cable

2.2 PoE

Power over Ethernet (PoE) connection.

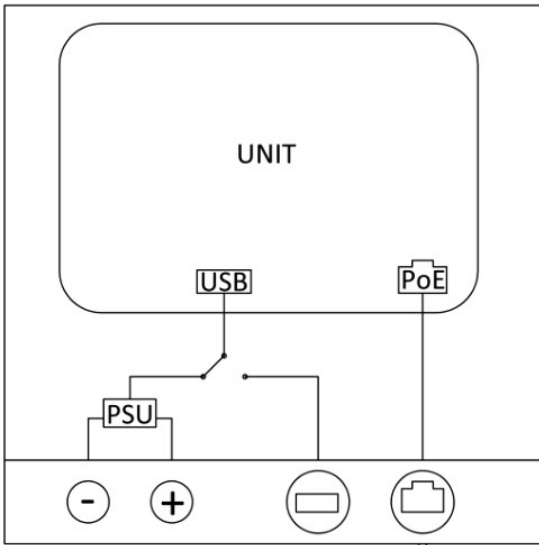

External Ethernet Cable 53-400811-XX-0300 (3 meters)



Maintain this USB connection.

PoE



Secure the unused USB cable to the ethernet cable using cable tie.

 Always tighten the threaded cable securely to maintain the IP rating & prevent disconnection.

External ethernet cable

2.3 DC INPUT (5V/2A)

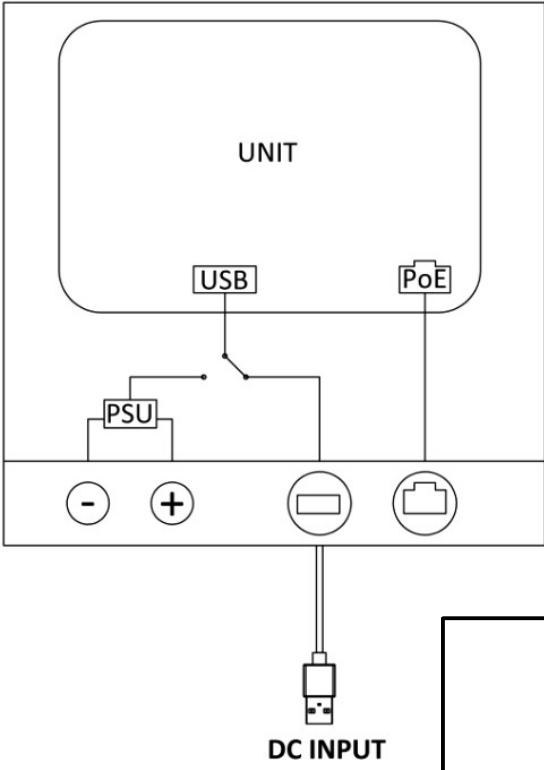

DC INPUT

External USB Cable 53-500411-XX-9009 (0.9 meter)





USB from M19 USB female panel

Maintain this connection



Secure the unused USB cable to the ethernet cable using cable tie.

Always tighten the threaded cable securely to maintain the IP rating & prevent disconnection.

External USB Cable

3. Circular Mount Accessory Installation

Circular Mount Accessory Installation

① Insert the provided steel belt (PKB-10S) into the slots of both the upper and lower brackets, as illustrated

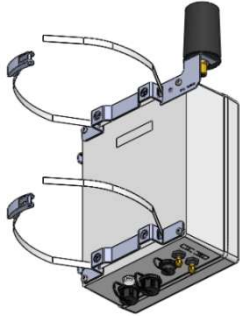

② Position the Edge Communication Hub Outdoor Unit vertically as shown and wrap the steel belt around the pole.

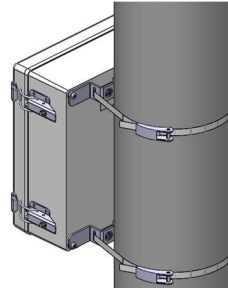

③ Pull the steel band tight, then fully cock the ratchet lever backward. Return the lever to its original position to secure the band.

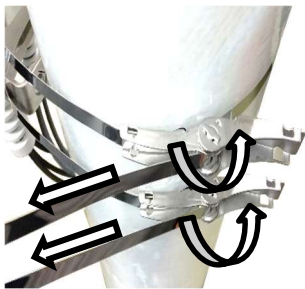

④ Cut the excess steel band to the desired length using appropriate cutting tools.



⑤ Fully Installed Edge Communication Hub Outdoor Unit on Circular Pole.

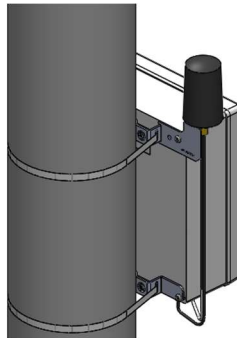
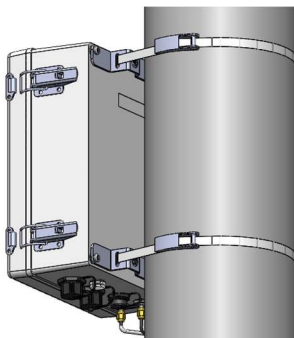

4. Stobie Mount Accessory Installation

Stobie Mount Accessory Installation

① Insert the provided steel belt (PKB-10S) into the slots of both the upper and lower brackets, as illustrated.



② Position and install the Top Hanger Plate (EE-509-0009), and secure it using the supplied bolt and nut. Align the metal bracket (EE-509-0017) underneath the top hanger slot. Tighten the nut after completing Step 4.

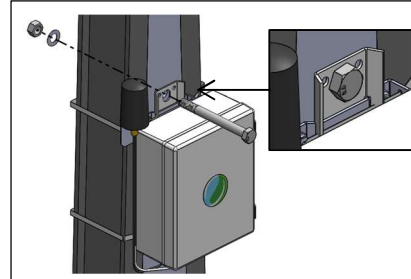

③ Wrap the steel belt around the Stobie pole as shown.

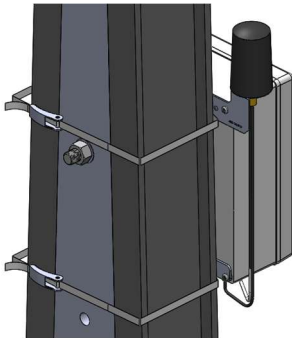

④ Pull the steel band tight, then fully cock the ratchet lever backward. Return the lever to its original position to secure the band.

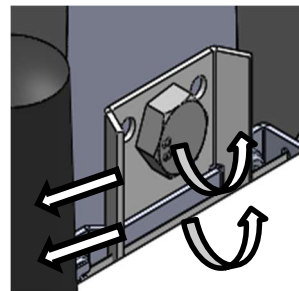



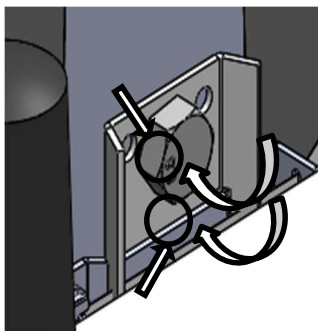

⑤ Cut the excess steel band to the desired length using appropriate cutting tools.

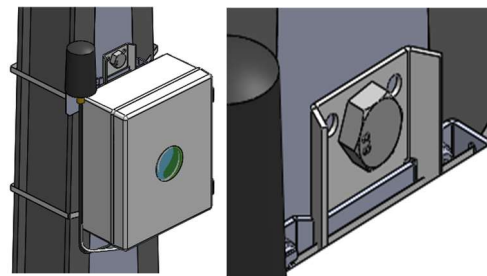

⑥ Fully installed Edge Edge Communication Hub Outdoor Unit.

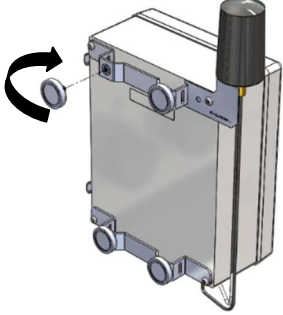

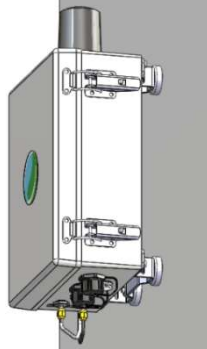
5. Pad Mount Accessory Installation

Pad Mount Accessory Installation	
<p>① Install the four supplied magnets (EE-508-0006) onto the bracket as shown. Screw the magnets in clockwise and tighten them by hand.</p> 	<p>② Attach the Edge Communication Hub Outdoor Unit to the metal surface, starting with the bottom magnet as shown.</p> 
<p>③ Carefully move the top of the Edge Communication Hub Outdoor Unit to properly align it in position.</p> 	<p>④ Fully Installed Edge Communication Hub Outdoor Unit on Pad (Metal Cabinet).</p> 
<p>⑤ HANDLE WITH CAUTION</p> <ul style="list-style-type: none"> • Always wear gloves when handling magnets to prevent pinching. These magnets are rated at 4 kg-force. • Magnets can be harmful to pacemaker wearers and individuals with medical implants. • Keep tools and other metal objects away. • When dismantling the Edge Communication Hub Outdoor Unit with magnet mounting, perform the reverse of the installation with caution. <div style="text-align: center;">  </div>	

V. DEVICE USAGE

1. Accessing Edge Communication Hub UI

A. Connect to ECH via Wi-Fi AP

- Connect to Edge Communication Hub based on the last 5 characters of the Serial Number.

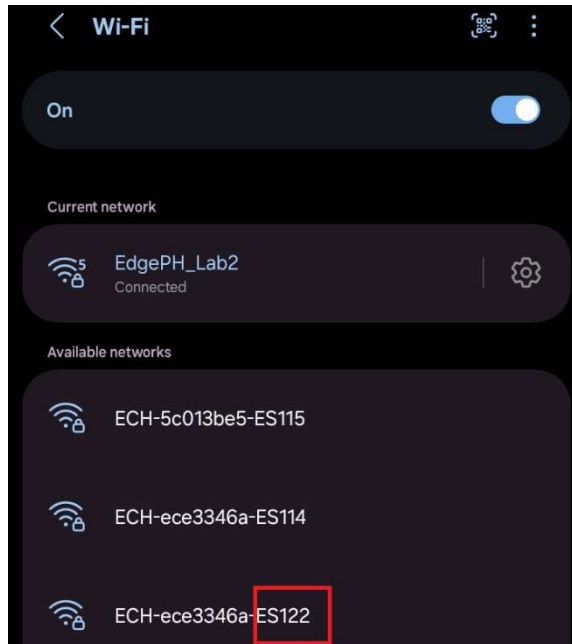

- The password is "12345678"

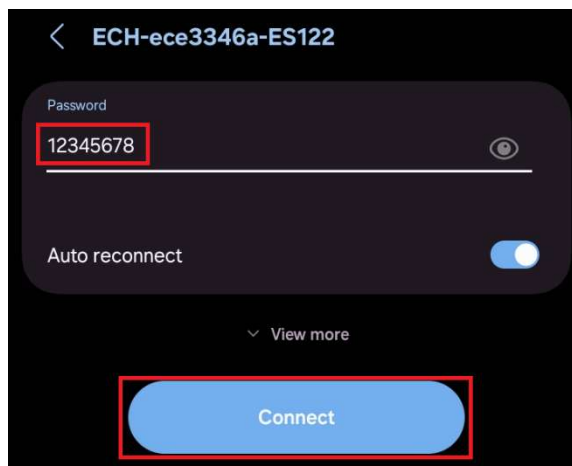

- Make sure to always connect even without internet connection

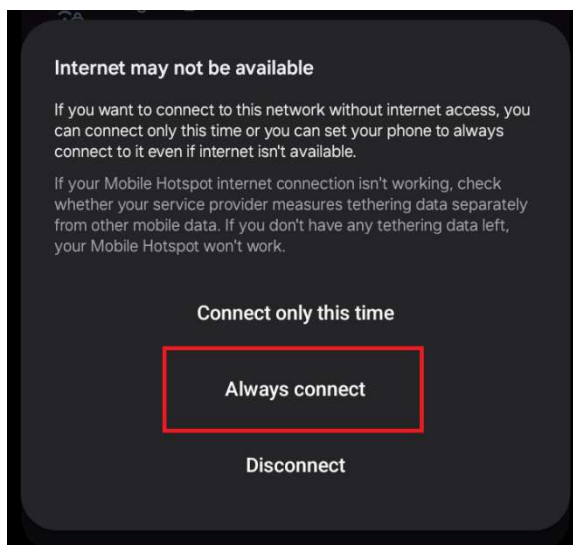

- d. Open the browser and go to 192.168.4.1

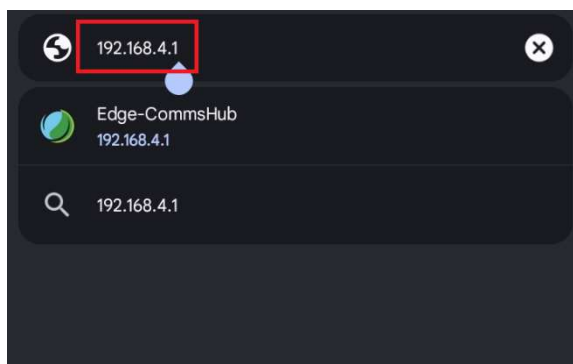

- e. The Edge Communication hub UI webpage will load

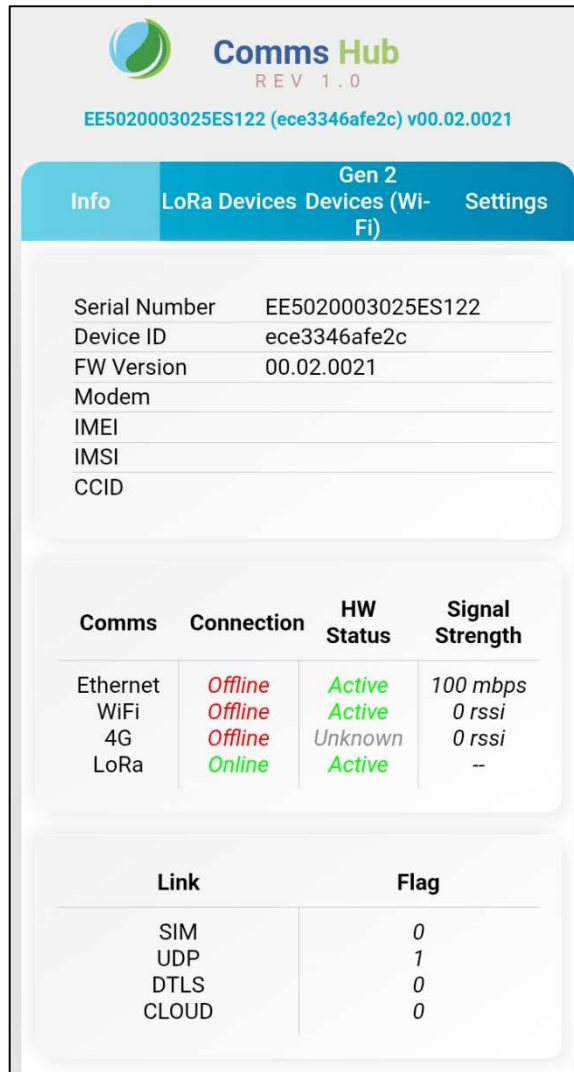

Comms Hub
 REV 1.0
 EE5020003025ES122 (ece3346afe2c) v00.02.0021

Info | **LoRa Devices** | **Gen 2 Devices (Wi-Fi)** | **Settings**

Serial Number	EE5020003025ES122
Device ID	ece3346afe2c
FW Version	00.02.0021
Modem	
IMEI	
IMSI	
CCID	

Comms	Connection	HW Status	Signal Strength
Ethernet	Offline	Active	100 mbps
WiFi	Offline	Active	0 rssi
4G	Offline	Unknown	0 rssi
LoRa	Online	Active	--

Link	Flag
SIM	0
UDP	1
DTLS	0
CLOUD	0

B. Change Wi-Fi Credentials

- a. Open the Edge Communication Hub UI (see section V. 1. A.). Click settings



Comms Hub
 REV 1.0
 EE5020003025ES122 (ece3346afe2c) v00.02.0021

Info | **LoRa Devices** | **Gen 2 Devices (Wi-Fi)** | **Settings**

- b. Input the credentials in the Wi-Fi SSID and Wi-Fi Password of your router and click update credentials. Enable the Station switch

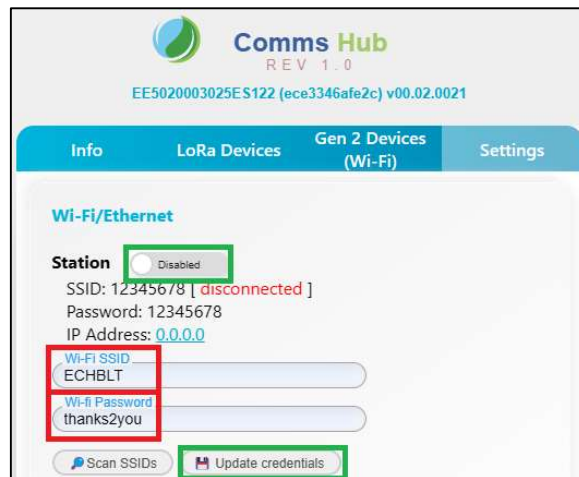

- c. Refresh the page and see the connection status



C. Add Custom APN

- a. Open the Edge Communication Hub UI (see section V. 1. A.). Click settings



Comms Hub
REV 1.0

EE5020003025ES122 (ece3346afe2c) v00.02.0021

Info
Gen 2
LoRa Devices Devices (Wi-Fi)
Settings

Serial Number EE5020003025ES122

Device ID ece3346afe2c

FW Version 00.02.0021

Modem

IMEI

IMSI

CCID

Comms	Connection	HW Status	Signal Strength
Ethernet	Offline	Active	100 mbps
WiFi	Offline	Active	0 rssi
4G	Offline	Unknown	0 rssi
LoRa	Online	Active	--

Link	Flag
SIM	0
UDP	1
DTLS	0
CLOUD	0

b. Under Modem. Click edit

Cellular

Modem Enabled

Access Point Names

0 connect.sg.cxn (used)

1 quectel.tn.std

2 custom [custom] edit

status: connecting, 1/3 retries

c. Input the custom apn

Cellular

Modem Enabled

Access Point Names

0 connect.sg.cxn (used)

1 quectel.tn.std

2 internet.cxn edit

status: connecting, 1/3 retries

- d. Custom APN will be used as a backup APN

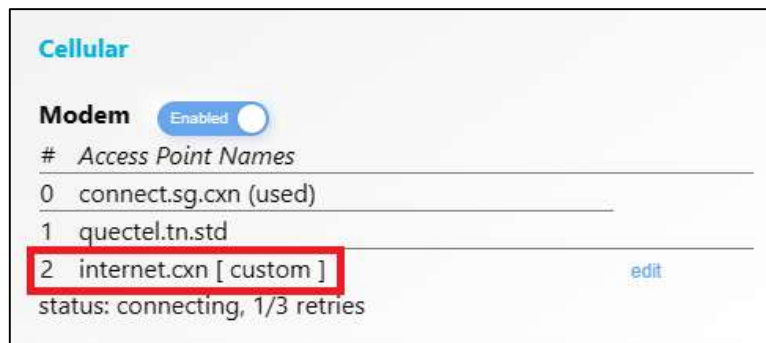

D. Bootloading Process

- a. Open the Edge Communication Hub UI (see section V. 1. A.). Click settings



- b. Under Main FW Update click choose file



- c. Select the update file

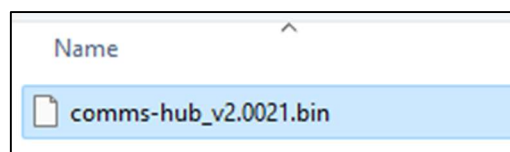

- d. Click Upload Firmware

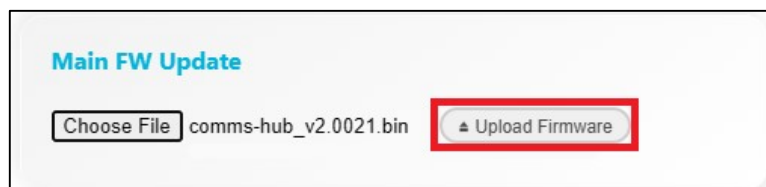

- e. Wait for the firmware update to finish

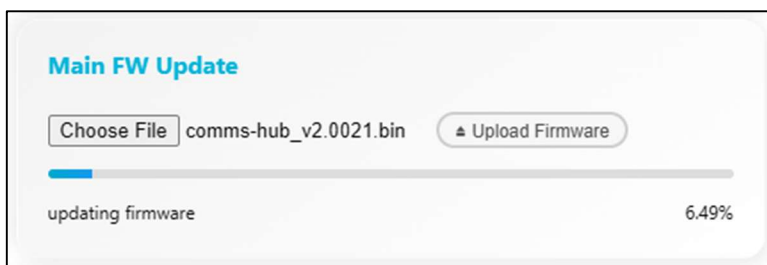

2. LEDs and Buttons

A. AP Button Functionality

WPS Mode

This mode enables the device to connect to the router without entering any credentials. To enable this mode, press and hold the AP button for 5 seconds. The WIFI/BT LED will blink slowly every one (1) second. Then press the WPS button of the router.

Access Point Mode

This mode enables the access to the web UI through its Access Point where you can change Wi-Fi credentials or network APN. Hold the AP button for 5 more seconds after WPS mode is set. The Wi-Fi/BT LED will blink four (4) times every second. This will be the default mode upon device power up.

Normal Mode

To switch back to normal mode, hold the AP button for 5 more seconds after Access Point mode is set. The Wi-Fi/BT LED will be turned off shortly, then its light up routine will switch back to normal upon releasing the button.

B. LED Functionality

The unit has 4 status LEDs for Power, LoRa, Wi-Fi, and 4G.

INDICATOR	LED	STATUS
PWR	OFF	No Power to ESP32
	SOLID	Power to ESP32
LoRa	OFF	No mesh detected/Not Connected to Mesh/LoRa Disabled
	BREATHING (1HZ)	Connected to Mesh but Not Connected to Cloud Server
	SOLID	Connected to Mesh and Cloud Server
Wi-Fi (AP MODE OFF)	OFF	Not connected to Wi-Fi/Wi-Fi Disabled
	SLOW BLINK (1 HZ, 0.5 sec on, 0.5 sec off)	Wi-Fi Protected Setup (WPS) mode
	PULSE (0.33 HZ; 1 sec on, 2 sec off)	Connected to Wi-Fi, Not Connected to Cloud Server
	SOLID	Connected to Wi-Fi, Connected to Cloud Server
Wi-Fi (AP MODE ON)	FAST BLINK (4 HZ, 0.125 sec on, 0.125 sec off)	Not connected to Wi-Fi
	N/A	N/A
	FAST BLINK (4 HZ, 0.125 sec on, 0.125 sec off)	Connected to Wi-Fi, Not Connected to Cloud Server
	BREATHING (1HZ)	Connected to Wi-Fi, Connected to Cloud Server
4G	OFF	4G Not Connected / 4G Disabled
	FAST BLINK (4 HZ, 0.125 sec on, 0.125 sec off)	4G Modem Hardware is OK
	BREATHING (1HZ)	SIM OK
	PULSE (0.2 HZ; 1 sec on, 2 sec off)	Connected to 4G Network
	SOLID	Connected to Cloud Server
	SLOW BLINK (1 HZ, 0.5 sec on, 0.5 sec off)	RSSI < -85 dBm

3. Diagnostic Tool for Edge Devices

A. Edge LoRA Device Diagnostics

- a. Open the Edge Communication Hub UI (see section V. 1. A.). Click LoRA devices



- b. Click Meshmap



- c. A graph of active LoRA nodes will be displayed

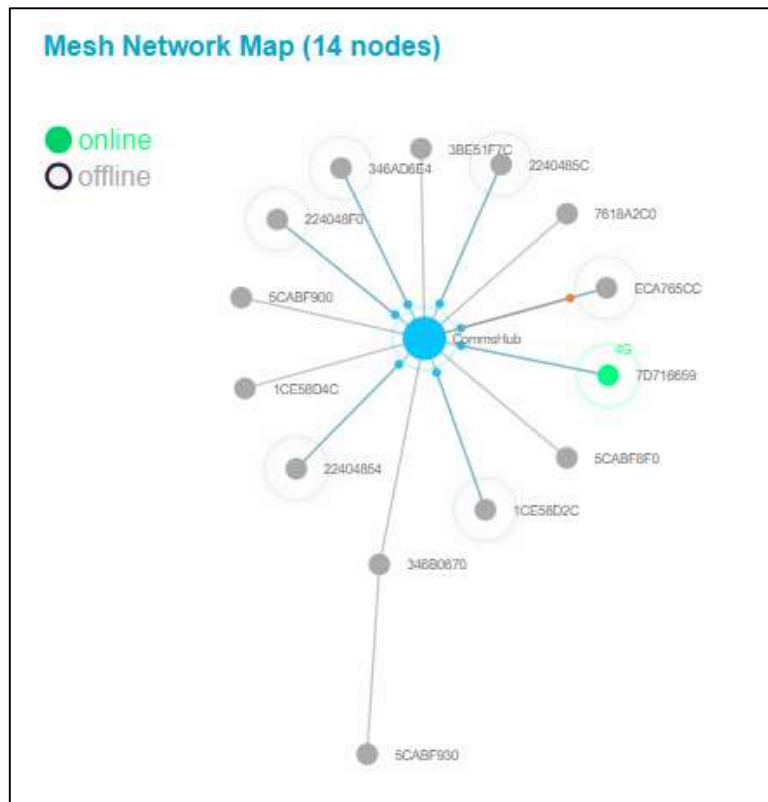

d. Click Select Node

LoRa Nodes(14)

Device Type: unknown

Queueing: auto manual

Measurement: 1-sec 1-minute (average)

Critical Data no record

Parameters

Non-Critical Data no record

Parameters

◀ ————— ▶

e. Click any Edge LoRa Node to observe real-time PQ data being obtained by that Edge device.

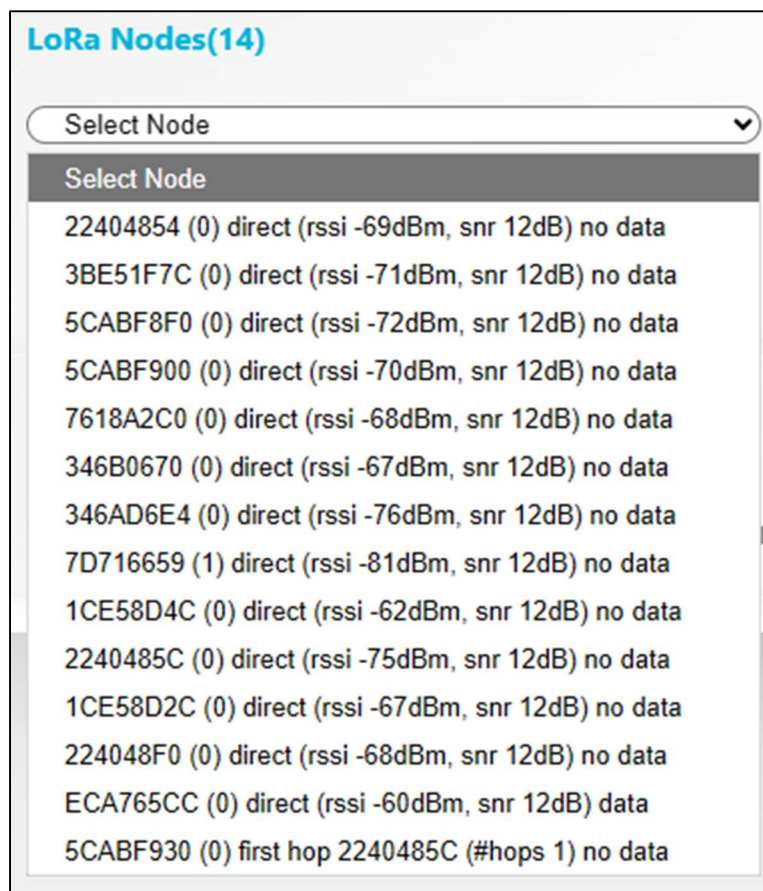

B. Edge Wi-Fi Device Diagnostics

- Click Gen 2 Devices (Wi-Fi)



- Enter the Network ID and the range of the Host IDs to be scanned (the default is 192.168.0.1-255). Press "Start" then wait for the scanning process to finish.



- c. Select the Edge Device from the list and then click Open.



- d. The Web UI of the Edge Device will load



Note: Only energy monitor devices connected on the same Wi-Fi network as the Edge Communication Hub will appear on the hosts selection list.